

Mini D Ribbon Connectors

Screw version

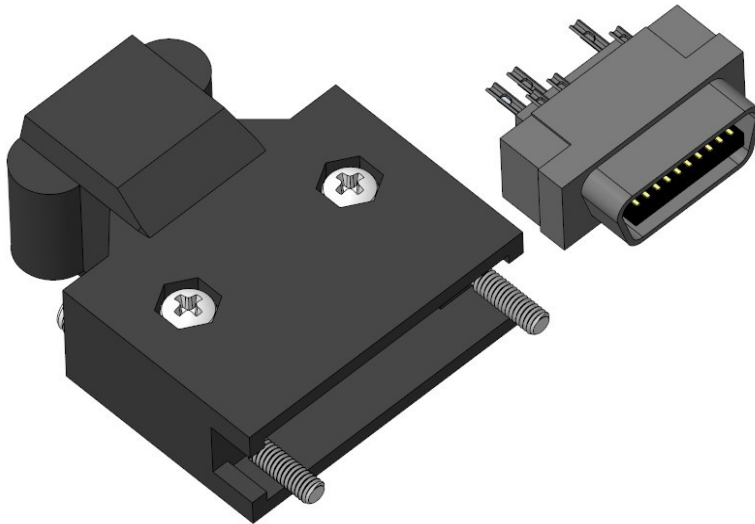

Z 8AA 00 20A MRDA 000

Technische Daten / technical data

Kontakt/ contact	20
Nominal Temperatur für Gehäuse / nominal temperature for shell	-55°C ... +105°C
Nominal Temperatur für Isolierkörper / nominal temperature for insert	-20°C ... +85°C
Lötprozess / solder process	360°C max for 10 sec. Max

Elektrische Daten für Isolierkörper / electrical datas for insert

Bemessungsstrom / nominal current	[A] 1A
Isolationswiderstand / insulation resistance	[Ω] >1 x 108Ω at 500 VDC
Widerstandsfähige Spannung / withstanding voltage	[V] 500 VRMS for 1 minute
Kurzzeitstromfestigkeiten / short-time withstand current	[A] 3x 1s with 340A

Material - Oberfläche / material - surface

Gehäuse / shell	PBT GF
Isolierkörper / insulation insert	Glass Reinforced Polyester
Kontakte / contacts	Copper Alloy , Plating:- Gold Flash over Nickel



Vor Verwendung der angegebenen Informationen und Daten, muss sich der Anwender über Aktualität und Gültigkeit dieser Ausfertigung rückversichern. Die Gültigkeit dieses Dokuments erlischt bei Gesetzgebungs- bzw. Normenänderung. Etwaige Schutzrechte sowie bestehende Gesetze sind vom Anwender in eigener Verantwortung zu beachten. Die Angaben der Crimpbereiche beziehen sich auf feindrähtige Litzen H05(07)V-K[#qmm] gemäß DIN VDE 0281/0282 ff, sowie auf nicht verdichtete Standardleitungen und -litzen gemäß DIN VDE 0295. Before using the information and data provided, the user have to re-insure the topicality and validity of this document. The validity of this document expires in the case of legislative changes and changes to standards. Any rights of protection as well as existing laws are to be observed by the user in his own responsibility. Mentioned crimp ranges are only valid with flexible wires H05(07)V-K[#qmm] acc. to DIN VDE 0281/0282 pp, and with non compressed standard cables and wires acc. to DIN VDE 0295.

Plastic solder plug with 14, 20, 26, 36, & 50 position:-

Contact Quantity	Dimensions		
	A	B	C
14	.72 [18.2]	1.16 [29.5]	.929 [23.6]
20	.87 [22.0]	1.31 [33.3]	1.08 [27.4]
26	1.02 [25.8]	1.46 [37.2]	1.23 [31.3]
36	1.27 [32.2]	1.71 [43.5]	1.48 [37.6]
50	1.62 [41.1]	2.06 [52.4]	1.83 [46.5]

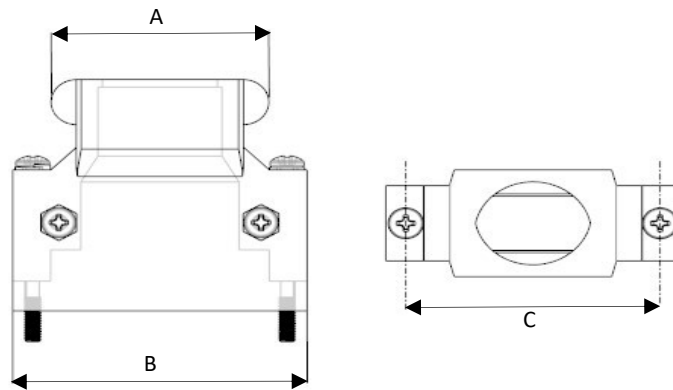

Plastic solder insert with 14, 20, 26, 36, & 50 position:-

Contact Quantity	Dimensions		
	A	B	C
14	.300 [7.62]	.54 [13.8]	.72 [18.2]
20	.450 [11.43]	.69 [17.6]	.87 [22.0]
26	.600 [15.24]	.85 [21.5]	1.02 [25.8]
36	.850 [21.59]	1.09 [27.8]	1.27 [32.2]
50	1.200 [30.48]	1.44 [36.7]	1.62 [41.1]

