

THE INFORMATION CONTAINED IN THIS DRAWING IS THE SOLE PROPERTY OF YAMAICHI ELECTRONICS DEUTSCHLAND GmbH. ANY REPRODUCTION IN PART OR WHOLE WITHOUT THE WRITTEN PERMISSION OF YAMAICHI ELECTRONICS DEUTSCHLAND GmbH IS PROHIBITED.

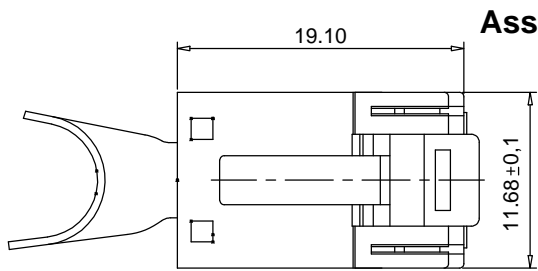

Assembly before crimping

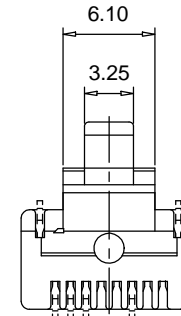
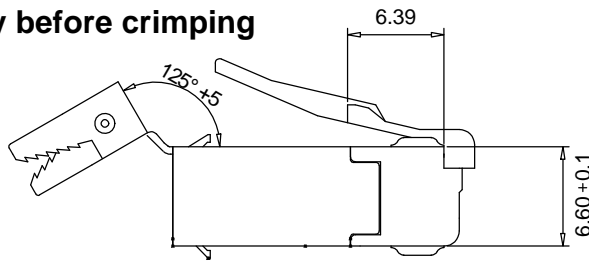

Contacts for stranded wire

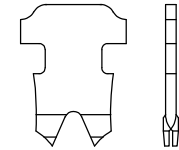

Assembly after crimping

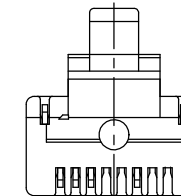
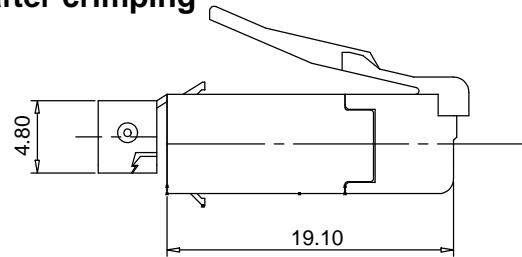
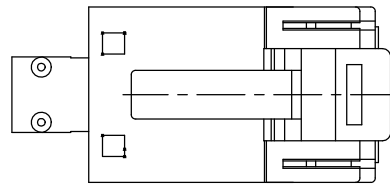

INSERT

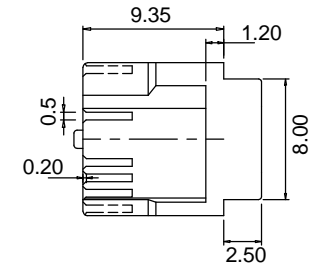

Shield after round crimping

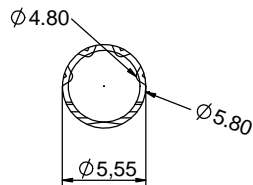

After square crimping

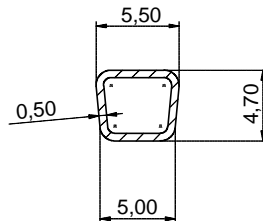

Shield

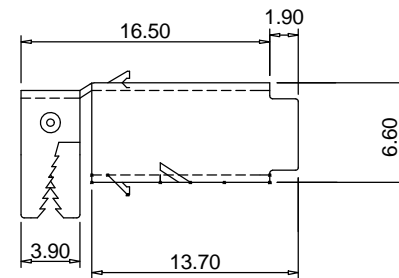

Material :
Housing material : PBT
Durability : 2000 mating cycles
Contact blade : phosphor Bronze
High strenght copper alloy
100 microinches nickel under plated &
gold selected 30 microinches

UNLESS OTHERWISE SPECIFIED: DIMENSIONS ARE IN MILLIMETERS TOLERANCES: ±0.3		REV.	REVISION DESCRIPTION	INITIALS	REV. DATE
		5			
		4			
		3			
		2			
		1			
		DO NOT SCALE DRAWING			CLASSIFICATION:
NOTES:		NAME	DATE	Customer-drawing	
		DESIGN		TITLE: Y-CON Plug-21 / 8(4)+2 Ethernet RJ45plus with power contacts	
		DRAWN			
		CHECKED			
ANGLE PROJECTION: First		Q.A.		DWG NO: Customer-P(090)A11	REV. ORIGIN B -
		APPROVED		SHEET 1 OF 1 A3 - ASSEMBLY	

THE INFORMATION CONTAINED IN THIS DRAWING IS THE SOLE PROPERTY OF YAMAICHI ELECTRONICS DEUTSCHLAND GmbH. ANY REPRODUCTION IN PART OR WHOLE WITHOUT THE WRITTEN PERMISSION OF YAMAICHI ELECTRONICS DEUTSCHLAND GmbH IS PROHIBITED.

CONFIDENTIAL

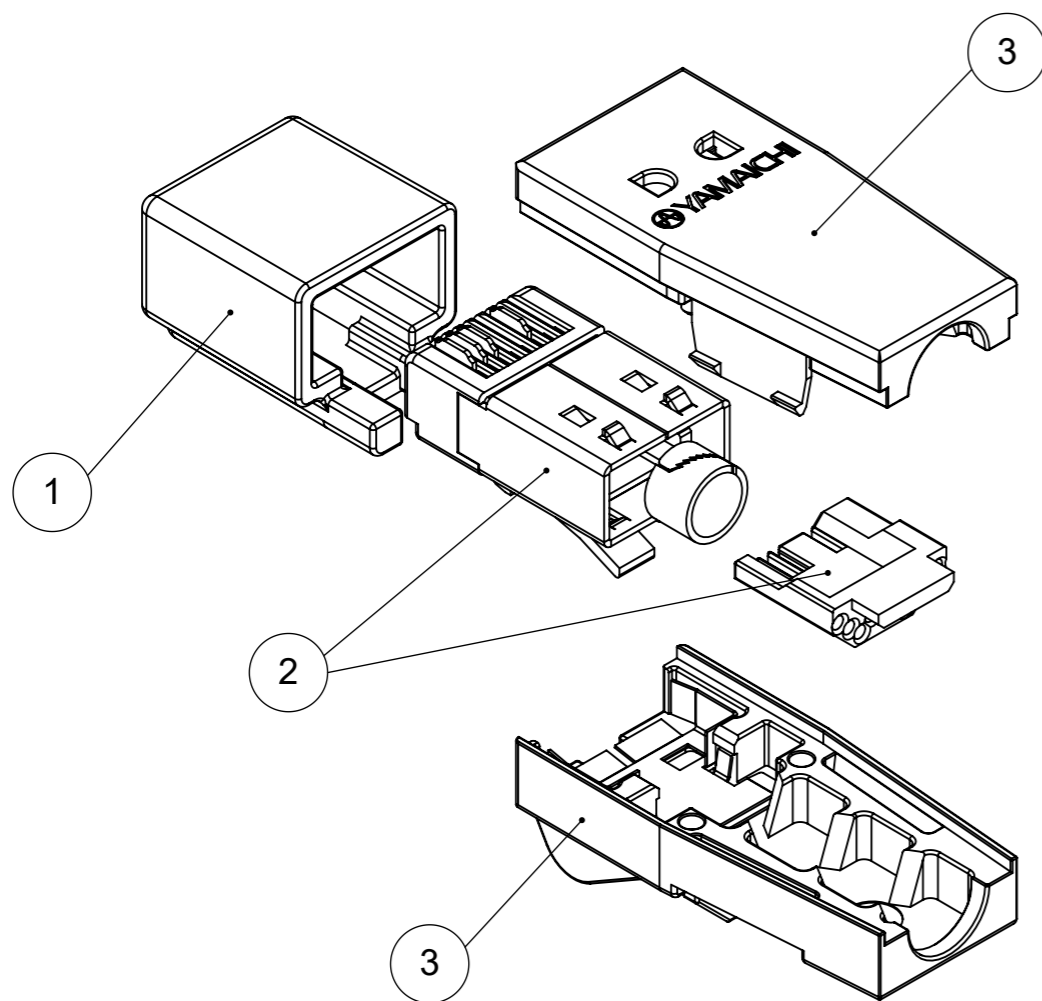

Dimensions of assembled Kit (w/o cable and Y-CONAS-12)

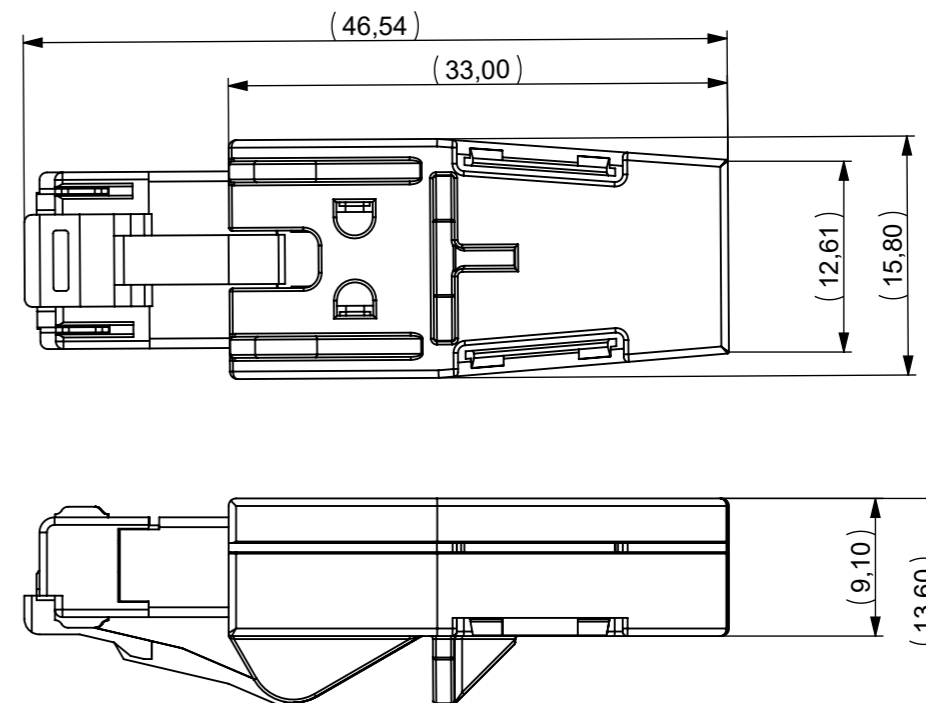

BOM / Stücklistentabelle

ITEM	QTY.	BIOS	ZEICH.Nr.
1	1	82-00070	Y-ConAS-12
2	1	see Variations	Y-ConPlug-xx
3	1	82-00789	Y-CONCOVER-20-TC-Y

Table of Variationen

TITLE	BIOS	Y-CONPLUG (2)
Y-CONKIT-COV-20-TC-PL21	82-00868	Y-CONPLUG-21 (82-00053)
Y-CONKIT-COV-20-TC-PL51	82-00869	Y-CONPLUG-51 (82-00410)
Y-CONKIT-COV-20-TC-PL11	82-00870	Y-CONPLUG-11 (82-00096)

Label :

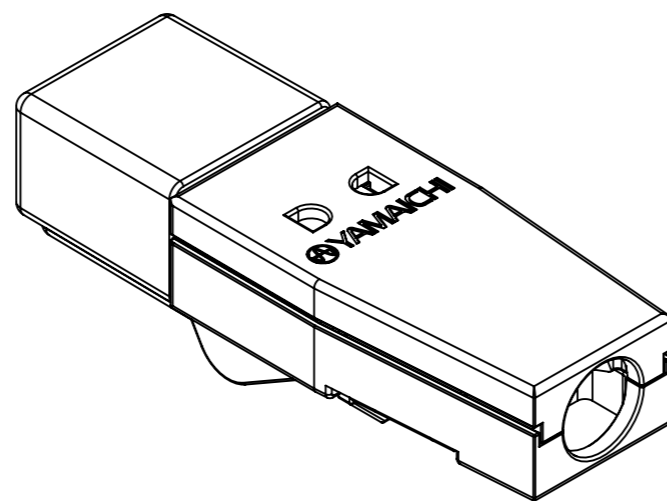
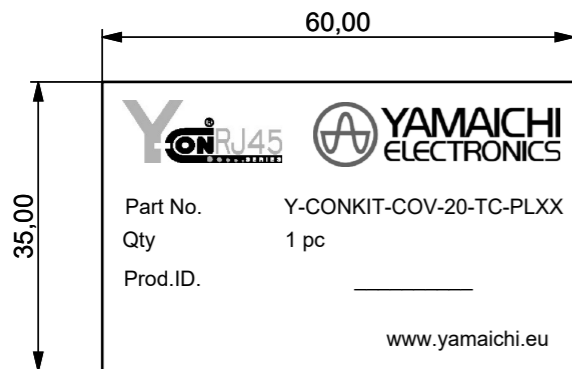

Yamaichi acts with all markings of the product exclusively on behalf of the customer as service provider and not as distributor. Yamaichi is not aware of the customer's end use/application. The customer indemnifies Yamaichi from any liability towards third parties in connection with the marking - with the exception of the legal exclusions of liability according to § 309 No. 7 BGB.

Specification/Drawing subject to alteration without prior notice

RoHS compliant acc. to directive 2011/65/EU

Unless otherwise specified : Dimensions are in millimeters TOLERANCES		REV.	REVISION DESCRIPTION	INITIALS	REV. DATE
		△			
		△			
		△			
		△			
Order / Article No. see table		DO NOT SCALE DRAWING		CLASSIFICATION: IP20 EMI RJ45 field kit	
NOTES: A3	ANGLE PROJECTION: FIRST	NAME	DATE	TITLE: Y-CONKIT-COV-20-TC-PLXX	
		CREATED M189	16.12.2019	DWG NO.: Customer-P(090)A03	
		MODIFIED M189	17.12.2019	REVISION: 001	
		RELEASED M161	17.12.2019	SCALE: 2:1	
WEIGHT:		SUBREV01		SHEET 1 OF 1	A3 - ASSEMBLY

